

# SITAGPOINT Tec2



**SITAG**  
swiss style at work



**| D |** Danke! Sie haben sich für einen Funktionsdrehstuhl der Firma SITAG entschieden und somit optimale Voraussetzungen für ein aktives, dynamisches Sitzen und gesundes Arbeiten geschaffen. Nur in einem richtig eingestellten und der Person angepassten Funktionsdrehstuhl erfüllt dieser die ergonomischen Aspekte. Diese Bedienungsanleitung beschreibt sämtliche Funktionen, z.T. sind diese jedoch modellabhängig und können somit variieren. Und nun viel Vergnügen beim Sitzen.

**| E |** Thank you! You have chosen a functional swivel chair by SITAG, and that means you have created optimal conditions for active, dynamic sitting and a healthy working posture. However, only if your functional swivel chair is correctly adjusted and adapted to your individual needs can you be sure that it satisfies all the ergonomic demands. This Instruction Manual describes all the functions, some of which vary depending on the model. So now we wish you happy and comfortable sitting!

**| F |** Merci! Vous avez opté pour un siège fonctionnel pivotant SITAG et vous constaterez que l'assise à la fois dynamique et active vous aidera à travailler dans des conditions plus optimales et saines pour votre santé. Car un siège se doit pour répondre à des critères d'ergonomie, d'être bien réglé et parfaitement adapté à la personne qui s'y assoit. Cette notice d'utilisation décrit toutes les fonctions du siège qui dépendent cependant des modèles et peuvent donc varier d'un modèle à l'autre. Et maintenant, profitez bien du confort que vous procure ce siège.

**| I |** Grazie! Con l'acquisto di una sedia operativa girevole della ditta SITAG, potrete finalmente lavorare in modo sano grazie alla sua seduta attiva e dinamica. Solo una seduta correttamente regolata e adattata alle esigenze delle singole persone soddisferà ogni aspetto ergonomico. Nelle presenti istruzioni per l'uso sono descritte le funzioni di tutti i modelli; vi preghiamo di controllare il modello da voi acquistato e di riferirvi alle relative descrizioni. Non ci resta che augurarvi che sedervi sia sempre piacevole e confortevole.

Danke  
Thanks  
Merci  
Grazie

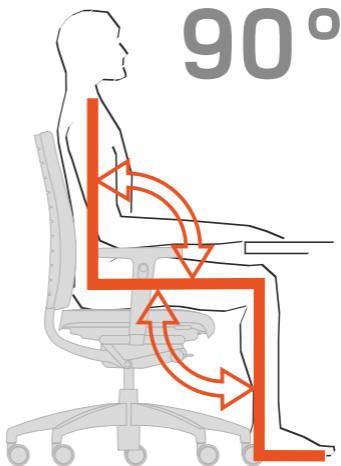

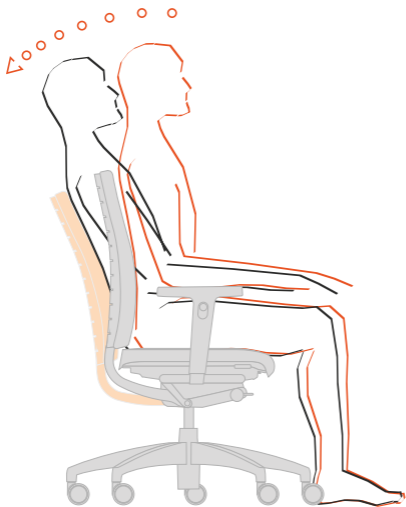

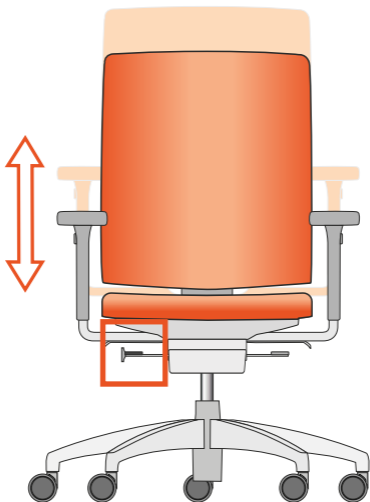
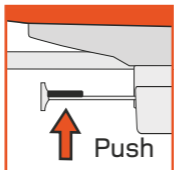

6

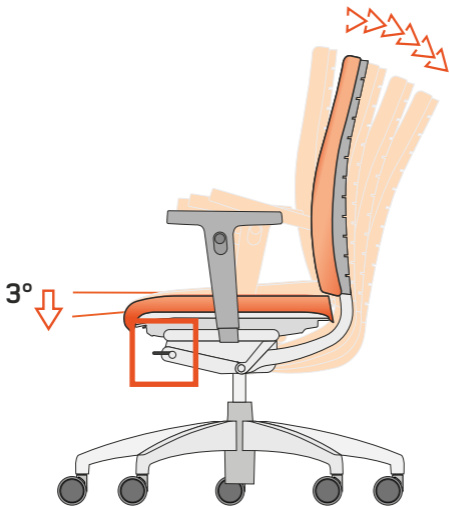
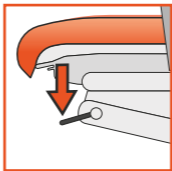

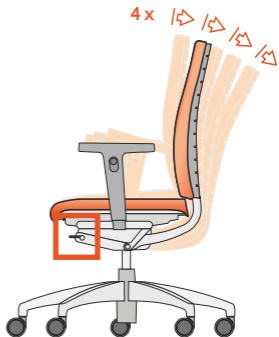
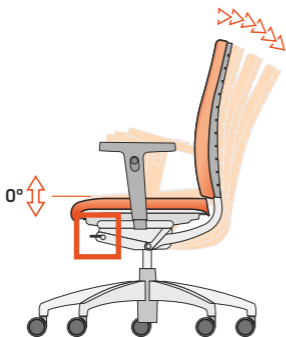
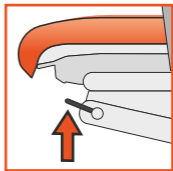
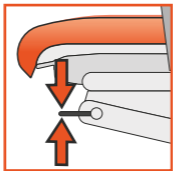





(Option)

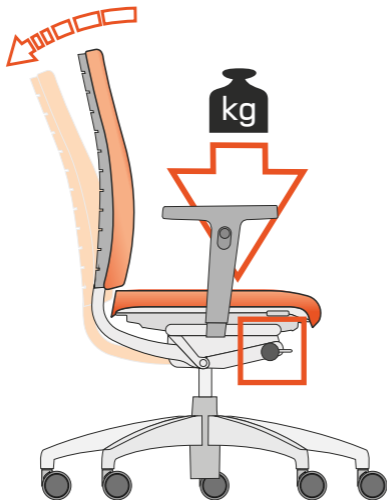

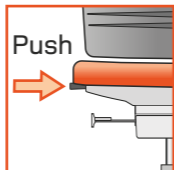

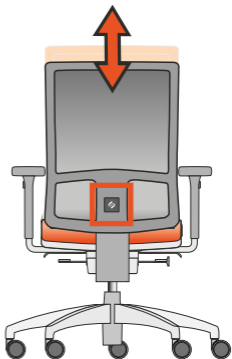
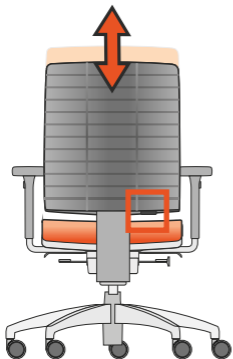

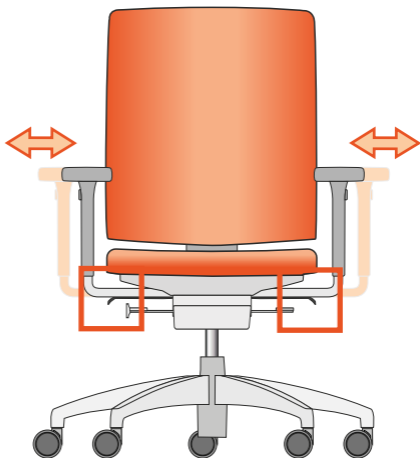
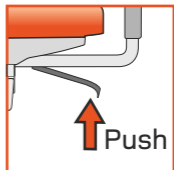
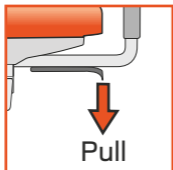

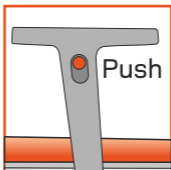



(Option)

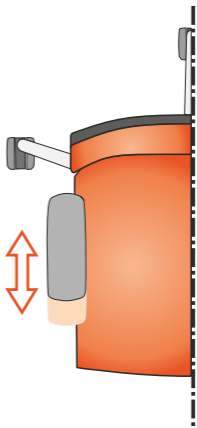
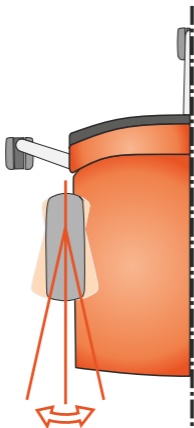
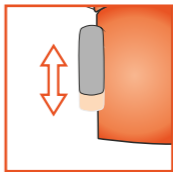
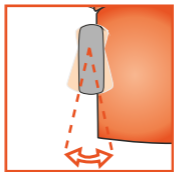

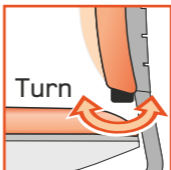

(Option)

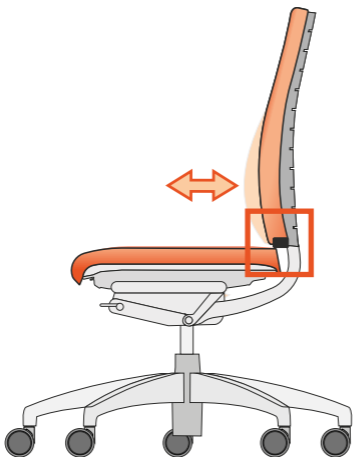



(Option)

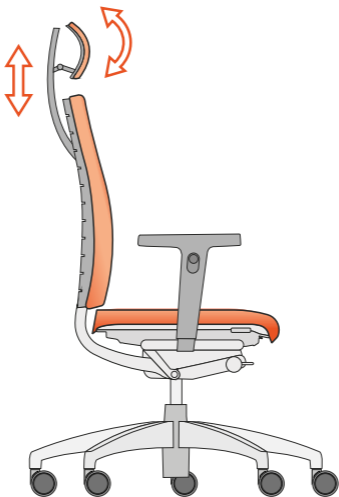





**| D |** Reparatur- und Montagearbeiten an den Gasfedern darf nur durch eingewiesenes Fachpersonal durchgeführt werden. Nutzen Sie Ihren Funktionsdrehstuhl nur bestimmungsgemäss. Bei unsach-gemässer Verwendung, z.B. als Aufstiegshilfe oder Sitzen auf den Armlehnen, besteht Unfallgefahr.

**| E |** Repairs and assembly jobs on the gas springs must always be performed by trained staff. Use your functional swivel chair only for its intended purpose. Risk of accident if it is used for any purpose for which it is not intended, e.g. do not stand or climb on it or sit on the arms.

**| F |** Seuls des spécialistes peuvent effectuer des travaux de réparation ou de montage sur les suspensions. Ne pas utiliser votre siège fonctionnel pour d'autres applications que celles prévues. Une utilisation abusive du siège – se mettre en position debout sur l'assise ou s'asseoir sur les accoudoirs par exemple –, peut conduire à des risques d'accident.

**| I |** Gli interventi di riparazione e/o montaggio degli ammortizzatori pneumatici devono essere affidati esclusivamente a personale qualificato e opportunamente addestrato. Utilizzate la vostra seduta operativa girevole nell'ambito dell'uso previsto. Se usata impropriamente, per esempio montandoci sopra con i piedi o sedendosi sui braccioli, esiste il pericolo di infortuni.

**Achtung  
Caution  
Attention  
Attenzione**



## Laufrollen Castors Roulettes Ruote

**| D |** Laufrollen. Falsch eingesetzte Rollen haben Einfluss auf Ihre Sicherheit und können auch zu Beschädigungen des Bodenbelags führen. «Harte» Rollen sind für Teppichböden und «weiche» Rollen für Holz- und Kunststoffböden konzipiert. Die Rollen sind unterschiedlich gekennzeichnet: «Harte» Rollen sind einfarbig, «weiche» Rollen erkennen Sie an der farblich abgesetzten Lauffläche, ableitfähige Rollen sind mit einem «Blitz» gekennzeichnet.

**| E |** Castors: Wrongly installed castors will affect your safety and may also damage the flooring. «Hard» castors are intended for carpeted floors, and «soft» castors are for wood or plastic surfaces. The castors are marked differently to help you distinguish them. «Hard» castors are plain coloured, «soft» castors can be recognised by the coloured contact surface, and static-conducting castors are identified by a «flash of lightning».

**| F |** Roulettes: Une installation non conforme des roulettes peut entraver votre sécurité et risque d'endommager le revêtement du sol. Les roulettes «dures» sont prévues pour des sols avec moquette et les roulettes «souples» pour des sols en bois ou des sols avec un revêtement synthétique. Ces deux types de roulettes se distinguent facilement: les roulettes «dures» sont d'une seule teinte, les roulettes «souples» présentent une surface de roulement discernable par une autre teinte. Quant aux roulettes antiélectrostatiques, elles sont reconnaissables par un «éclair».

**| I |** Ruote: Eventuali ruote non inserite correttamente possono compromettere la vostra sicurezza, oltre a danneggiare il rivestimento del pavimento. Le ruote «dure» sono state concepite per la moquette, le ruote «morbide» per pavimenti sintetici e in legno. Le ruote sono contraddistinte da colori diversi: quelle «dure» sono di un colore, mentre quelle «morbide» si differenziano per il «battistrada» di colore diverso. Le ruote in grado di scaricare tensioni, infine, sono caratterizzate dal simbolo del «fulmine».

**| D |** Zum Säubern der Kunststoffteile dürfen keine lösungsmittelhaltigen Reiniger verwendet werden. Die Stoffbezüge lassen sich mit Trockenschaum einfach reinigen. Lederbezüge nur mit feuchten Lappen oder speziellen Reinigungsmitteln behandeln.

**| E |** Never use any detergents to clean the plastic parts. The textile covers can be cleaned easily with dry foam. Leather covers only need wiping with a damp cloth or special cleaning agent.

**| F |** L'utilisation de produit détergent est fortement déconseillée pour les parties en matière synthétique. Les revêtements en tissu se nettoient facilement à sec avec une mousse spéciale. Les revêtements en cuir demandent un entretien particulier avec une simple éponge humide ou alors avec des produits d'entretien spécifiques.

**| I |** Non usare detergenti a base di solventi per la pulizia delle parti in materiale sintetico. I rivestimenti in stoffa possono essere puliti facilmente con un po' di schiuma secca. I rivestimenti in pelle invece devono essere trattati solo con un panno umido oppure con detergenti specifici.



Reinigung  
Cleaning  
Nettoyage  
Pulizia

**| D |** Es gelten die allgemeinen Verkaufs- und Lieferbedingungen der Firma SITAG (www.sitag.ch, www.sitag.de).

**| E |** SITAG's general terms and conditions of sale and delivery apply. (www.sitag.ch, www.sitag.de)

**| F |** Se conférer aux conditions générales de vente et de livraison de l'entreprise SITAG. (www.sitag.ch, www.sitag.de).

**| I |** Sono valide le condizioni generali di vendita e di fornitura della ditta SITAG (www.sitag.ch, www.sitag.de).

**Garantie  
Guarantee  
Garantie  
Garanzia**

WEP-BAL\_S-POINT\_T2 03/18 /10000

 **swiss workstyle**

SITAG AG  
Simon Frick-Strasse 3  
CH-9466 Sennwald  
Tel. +41 81 758 18 18  
Fax +41 81 758 18 00

info@sitag.ch  
www.sitag.ch

SITAG – a Company of the Nowy Styl Group



**SITAG**  
swiss style at work

